



MODEL:AD-4BC-3W

Description: The adjustable head joints made of brass casting, pipe diameter and is mainly used to connect.

一. Constitution:

(1)Parts: 1)Adapter*1;



二. Technical Parameters And Related Matters:

1) Size:

Name	Material	A(mm)	B((in))	C((in))	D((in))
Adapter	Cu	62	1/2"	1/2"	1/4"

2)Diagram: (see photo):

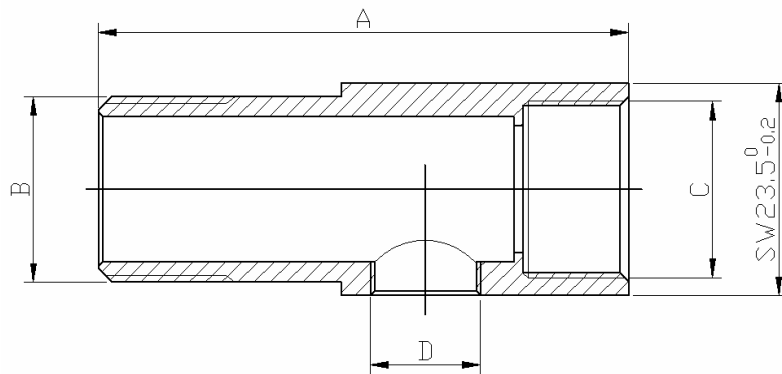

3)Packing:

Quantity of each package	N. W(Kg)	G. W(Kg)	L(mm)	W(mm)	H(mm)
250	21	22	35	24	18

Warning: Do not place in direct sunlight component.