

IRRIGATION SYSTEMS

CEPEX FILTRATION



LF FILTERS

	CODE
CEPEX MANUAL FILTER LF 3/4" B SCREEN 130 MICRON - Q 5M3/H	34910
CEPEX MANUAL FILTER LF 1" B SCREEN 130 MICRON - Q 6M3/H	34911
CEPEX MANUAL FILTER LF 1 1/4" B SCREEN 130M - Q 10M3/H	04132
CEPEX MANUAL FILTER LF 1 1/2" B SCREEN 130M - Q 14M3/H	04133
CEPEX MANUAL FILTER LF 2" B SCREEN 130 MICRON - Q 25M3/H	34912
CEPEX MANUAL FILTER LF 3" B SCREEN 130 MICRON - Q 48M3/H	34913

Standard filtration: 130 micras, on order: 100 and 200 micras.



LF FILTERS

	CODE
CEPEX MANUAL FILTER LF 3/4" B DISCS 130 MICRON - Q 5M3/H	09352
CEPEX MANUAL FILTER LF 1" B DISCS 130 MICRON - Q 6M3/H	09353
CEPEX MANUAL FILTER LF 1 1/4" B DISCS 130M - Q 10M3/H	46546
CEPEX MANUAL FILTER LF 1 1/2" B DISCS 130M - Q 14M3/H	19911
CEPEX MANUAL FILTER LF 2" B DISCS 130 MICRON - Q 25M3/H	46547
CEPEX MANUAL FILTER LF 3" B DISCS 130 MICRON - Q 48M3/H	32363

Standard filtration: 130 micras, on order: 100 and 200 micras.



	Connection	Maximum flow	Filtering surface (disc)	Filtering surface (screen)	Maximum temperature / pressure
CEPEX MANUAL FILTERS LF	3/4"	5 m ³ /h - 22 gpm	180 cm ² - 28 in ²	160 cm ² - 25 in ²	8 bar/116 psi - 60 °C/140 °F
	1"	6 m ³ /h - 26 gpm	180 cm ² - 28 in ²	160 cm ² - 25 in ²	8 bar/116 psi - 60 °C/140 °F
	1 1/4"	10 m ³ /h - 44 gpm	300 cm ² - 47 in ²	265 cm ² - 41 in ²	8 bar/116 psi - 60 °C/140 °F
	1 1/2"	20 m ³ /h - 88 gpm	525 cm ² - 81 in ²	485 cm ² - 75 in ²	8 bar/116 psi - 60 °C/140 °F
	1 1/2" LARGE	25 m ³ /h - 110 gpm	525 cm ² - 81 in ²	485 cm ² - 75 in ²	8 bar/116 psi - 60 °C/140 °F

Pressure loss

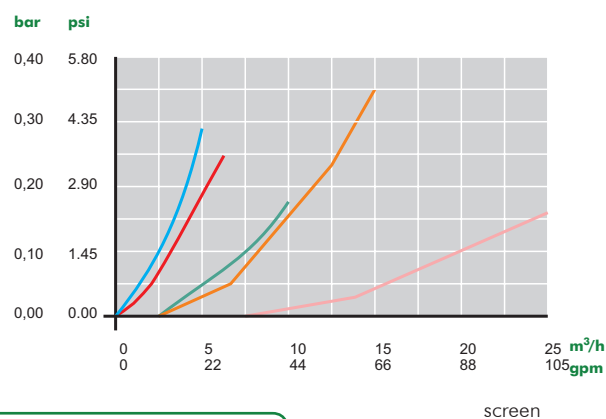
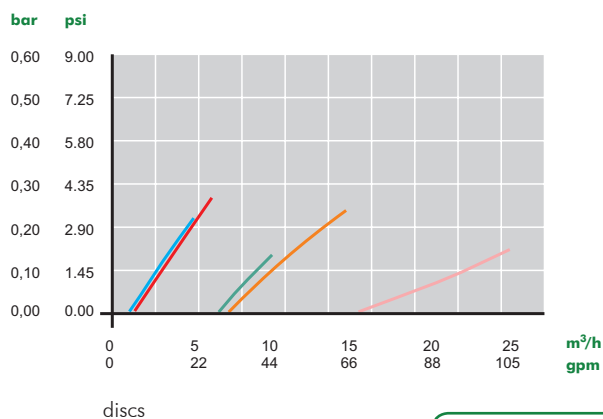

IRRIGATION SYSTEMS

CEPEX FILTRATION



MANUAL FILTERS HFL

MANUAL FILTERS HFL

	CODE
CEPEX MANUAL FILTER HFL 2 B DISC 130 MICRON 30M3/H	62270
CEPEX MANUAL FILTER HFL 2LARGE B DISC 130M 30M3/H	62272
CEPEX MANUAL FILTER HFL 3 B DISC 130 MICRON 50 M3/H	62274
CEPEX MANUAL FILTER HFL 3LARGE B DISC 130 MICRON 50 M3/H	62276

Standard filtration: 130 micras, on order: 100 and 200 micras.



MANUAL FILTERS HFL

	CODE
CEPEX MANUAL FILTER HFL 2 B SCREEN 130 MICRON 30 M3/H	62271
CEPEX MANUAL FILTER HFL 2LARGE B SCREEN 130M 30M3/H	62273
CEPEX MANUAL FILTER HFL 3 B SCREEN 130 MICRON 50M3/H	62275
CEPEX MANUAL FILTER HFL 3LARGE B SCREEN 130 MICRON 50M3/H	62277

Standard filtration: 130 micras, on order: 100 and 200 micras.



TWISTER FILTERS

	CODE
CEPEX TWISTER FILTER HF 2 B DISC 130 MICRON 30 M3/H	20364
CEPEX TWISTER FILTER HF 2LARGE B DISC 130M 30 M3/H	46548
CEPEX TWISTER FILTER HF 3 B DISC 130 MICRON 50 M3/H	57867
CEPEX TWISTER FILTER HF 3LARGE B DISC 130 MICRON 50 M3/H	20365

	Connection	Maximum flow	Filtering surface (disc)	Filtering surface (screen)	Maximum temperature / pressure
CEPEX MANUAL FILTERS HFL	2"	30 m ³ /h - 132 gpm	1.050 cm ² - 163 in ²	650 cm ² - 101 in ²	8 bar/116 psi - 60 °C/140 °F
	2" LARGE	30 m ³ /h - 132 gpm	1.660 cm ² - 257 in ²	960 cm ² - 149 in ²	8 bar/116 psi - 60 °C/140 °F
	3"	50 m ³ /h - 220 gpm	1.050 cm ² - 163 in ²	650 cm ² - 101 in ²	8 bar/116 psi - 60 °C/140 °F
	3" LARGE	50 m ³ /h - 220 gpm	1.660 cm ² - 257 in ²	960 cm ² - 149 in ²	8 bar/116 psi - 60 °C/140 °F

Standard: 130 microns - 8 bar
For other options, please ask.

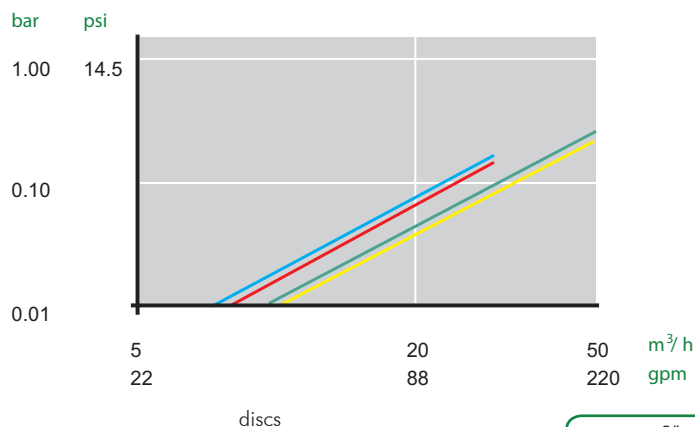

Pressure loss

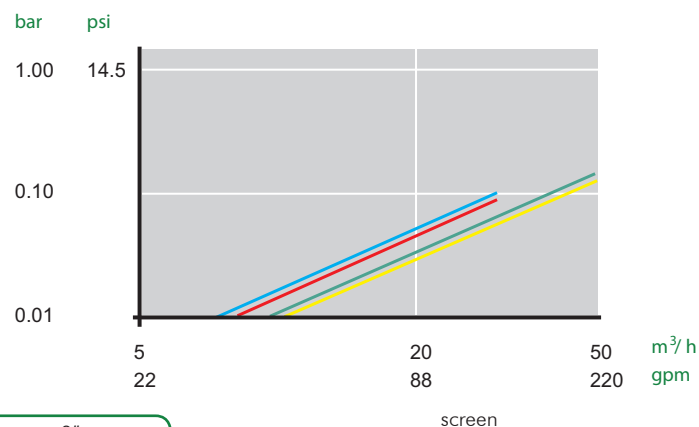

IRRIGATION SYSTEMS

CEPEX FILTRATION



AUTOMATIC TWISTER FILTERS

	CODE
CEPEX AUTOMATIC FILTER 2LARGE VVB 130MICRON 32 M3/H	46555
CEPEX AUTOMATIC FILTER 3 VVB 130 MICRON 64 M3/H	46556



AUTOMATIC FILTRATION BATTERIES

AUTOMATIC FILTRATION BATTERIES 2"

	CODE
CEPEX AUTOMATIC BATTERY 1x2" 100 MICRON 24 M3/H	47150
CEPEX AUTOMATIC BATTERY 1x2" 130 MICRON 24 M3/H	47151
CEPEX AUTOMATIC BATTERY 2x2" 3V 100 MICRON 48 M3/H	47152
CEPEX AUTOMATIC BATTERY 2x2" 3V 130 MICRON 48 M3/H	47153
CEPEX AUTOMATIC BATTERY 2x2" 3F 130 MICRON Q.MAX 48M3/H - FLANGE D90	46720
CEPEX AUTOMATIC BATTERY 3x2" 4F 130 MICRON Q.MAX 72M3/H - FLANGE D110	46721
CEPEX AUTOMATIC BATTERY 4x2" 6F 130 MICRON Q.MAX 96M3/H - FLANGE D160	46722
CEPEX AUTOMATIC BATTERY 5x2" 6F 130 MICRON Q.MAX 120M3/H - FLANGE D160	46723
CEPEX AUTOMATIC BATTERY 6x2" 6F 130 MICRON Q.MAX 144M3/H - FLANGE D160	46724

Standard filtration: 130 micras, on order: 100 and 200, 50, 20 and 5 micras



AUTOMATIC FILTRATION BATTERIES 3"

	CODE
CEPEX AUTOMATIC BATTERY 2x3" 4F 130 MICRON Q.MAX 64M3/H - FLANGE D110	46725
CEPEX AUTOMATIC BATTERY 3x3" 4F 130 MICRON Q.MAX 96M3/H - FLANGE D110	46726
CEPEX AUTOMATIC BATTERY 4x3" 6F 130 MICRON Q.MAX 128M3/H - FLANGE D160	46727
CEPEX AUTOMATIC BATTERY 5x3" 6F 130 MICRON Q.MAX 160M3/H - FLANGE D160	46728
CEPEX AUTOMATIC BATTERY 6x3" 6F 130 MICRON Q.MAX 160M3/H - FLANGE D160	46729
CEPEX AUTOMATIC BATTERY 6x3" 8F 130 MICRON Q.MAX 192M3/H - FLANGE D200	46730

Standard filtration: 130 micras, on order: 100 and 200, 50, 20 and 5 micras.



AUTOMATIC FILTRATION BATTERIES 4"

	CODE
CEPEX AUTOMATIC BATTERY 4x4" 8F 130 MICRON Q.MAX 192M3/H - FLANGE D200	46731
CEPEX AUTOMATIC BATTERY 5X4" 8F 130 MICRON Q.MAX 240M3/H - FLANGE D200	46732
CEPEX AUTOMATIC BATTERY 6x4" 10F 130 MICRON Q.MAX 288M3/H - FLANGE D200	46733
CEPEX AUTOMATIC BATTERY 7x4" 10F 130 MICRON Q.MAX 336M3/H - FLANGE D250	46734
CEPEX AUTOMATIC BATTERY 8x4" 10F 130 MICRON Q.MAX 384M3/H - FLANGE D250	46735
CEPEX AUTOMATIC BATTERY 9x4" 12F 130 MICRON Q.MAX 432M3/H - FLANGE D315	46736
CEPEX AUTOMATIC BATTERY 10X4" 12F 130 MICRON Q.MAX 480M3/H - FLANGE D315	46737

Standard filtration: 130 micras, on order: 100 and 200, 50, 20 and 5 micras.



IRRIGATION SYSTEMS

CEPEX FILTRATION



Connection x n° filters	Maximum flow x filter	Minimum backflus- hing pressure	Minimum backflus- hing flow	Filtering surface	Maximum temperature / pressure
2" x 1	20 m³/h - 88 gpm	2,8 bar - 40 psi	2,5 l/s - 39 gpm	1.492 cm² - 231.26 inch²	6 bar/90 psi - 60 °C/140 °F
2" x 2	20 m³/h - 88 gpm	2,8 bar - 40 psi	2,5 l/s - 39 gpm	2.984 cm² - 462.52 inch²	6 bar/90 psi - 60 °C/140 °F
2" x 3	20 m³/h - 88 gpm	2,8 bar - 40 psi	2,5 l/s - 39 gpm	4.476 cm² - 693.78 inch²	6 bar/90 psi - 60 °C/140 °F
2" x 4	20 m³/h - 88 gpm	2,8 bar - 40 psi	2,5 l/s - 39 gpm	5.968 cm² - 925.04 inch²	6 bar/90 psi - 60 °C/140 °F
2" x 5	20 m³/h - 88 gpm	2,8 bar - 40 psi	2,5 l/s - 39 gpm	7.460 cm² - 1156.3 inch²	6 bar/90 psi - 60 °C/140 °F
2" x 6	20 m³/h - 88 gpm	2,8 bar - 40 psi	2,5 l/s - 39 gpm	8.952 cm² - 1387.56 inch²	6 bar/90 psi - 60 °C/140 °F
3" x 2	32 m³/h - 139 gpm	2,8 bar - 40 psi	2,5 l/s - 39 gpm	2.984 cm² - 462.52 inch²	6 bar/90 psi - 60 °C/140 °F
3" x 3	32 m³/h - 139 gpm	2,8 bar - 40 psi	2,5 l/s - 39 gpm	4.476 cm² - 693.78 inch²	6 bar/90 psi - 60 °C/140 °F
3" x 4	32 m³/h - 139 gpm	2,8 bar - 40 psi	2,5 l/s - 39 gpm	5.968 cm² - 925.04 inch²	6 bar/90 psi - 60 °C/140 °F
3" x 5	32 m³/h - 139 gpm	2,8 bar - 40 psi	2,5 l/s - 39 gpm	7.460 cm² - 1156.3 inch²	6 bar/90 psi - 60 °C/140 °F
3" x 6	32 m³/h - 139 gpm	2,8 bar - 40 psi	2,5 l/s - 39 gpm	8.952 cm² - 1387.56 inch²	6 bar/90 psi - 60 °C/140 °F
4" x 4	63 m³/h - 279 gpm	2,8 bar - 40 psi	5 l/s - 78 gpm	11.936 cm² - 1850.08 inch²	6 bar/90 psi - 60 °C/140 °F
4" x 5	63 m³/h - 279 gpm	2,8 bar - 40 psi	5 l/s - 78 gpm	14.920 cm² - 2312.6 inch²	6 bar/90 psi - 60 °C/140 °F
4" x 6	63 m³/h - 279 gpm	2,8 bar - 40 psi	5 l/s - 78 gpm	17.904 cm² - 2775.12 inch²	6 bar/90 psi - 60 °C/140 °F
4" x 7	63 m³/h - 279 gpm	2,8 bar - 40 psi	5 l/s - 78 gpm	20.888 cm² - 3237.64 inch²	6 bar/90 psi - 60 °C/140 °F
4" x 8	63 m³/h - 279 gpm	2,8 bar - 40 psi	5 l/s - 78 gpm	23.872 cm² - 3700.16 inch²	6 bar/90 psi - 60 °C/140 °F
4" x 9	63 m³/h - 279 gpm	2,8 bar - 40 psi	5 l/s - 78 gpm	26.856 cm² - 4162.68 inch²	6 bar/90 psi - 60 °C/140 °F
4" x 10	63 m³/h - 279 gpm	2,8 bar - 40 psi	5 l/s - 78 gpm	29.840 cm² - 4625.2 inch²	6 bar/90 psi - 60 °C/140 °F

Standard: 130 microns - 6 bar
For other options, please ask.

Pressure loss

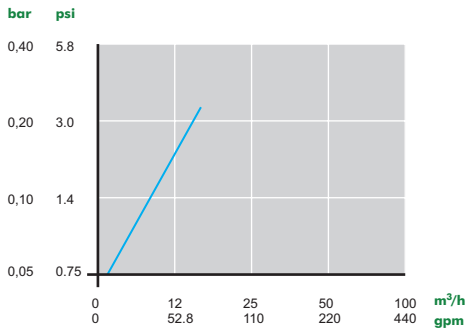

2" x 1 - 130 micron

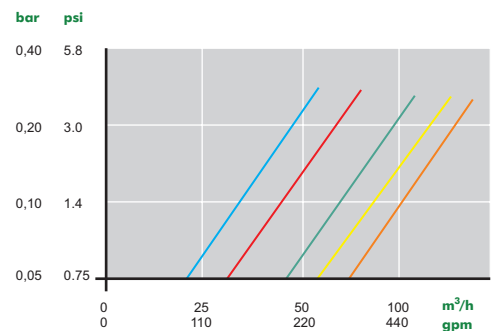

2" x 2, 2" x 3, 2" x 4, 2" x 5, 2" x 6

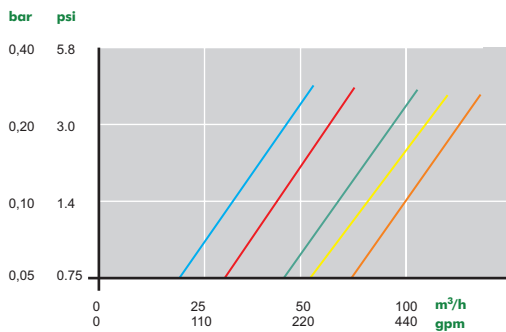

3" x 2, 3" x 3, 3" x 4, 3" x 5, 3" x 6

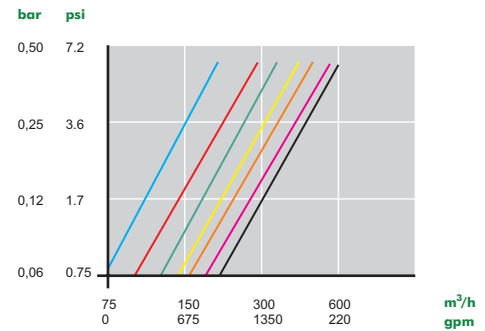

4" x 4, 4" x 5, 4" x 6, 4" x 7, 4" x 8, 4" x 9, 4" x 10

IRRIGATION SYSTEMS

CEPEX[®] MANUAL FILTERS LF

	H		W		X		D	
	mm	in	mm	in	mm	in	mm	in
3/4"	173	7	185	7	158	6	83	3
1"	173	7	190	7	168	7	133	5
1 1/4"	202	8	231	9	231	9	133	5
1 1/2"	202	8	231	9	231	9	115	5
2"	248	10	270	11	267	11	144	6

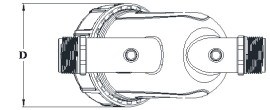
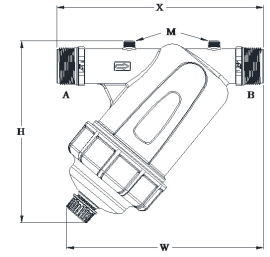

MANUAL FILTERS HFL

	H		W		X		D	
	mm	in	mm	in	mm	in	mm	in
2"	445	17.5	286	11.2	75	3.0	231	9.1
2" LARGE	595	23.4	286	11.2	75	3.0	231	9.1
3"	495	19.5	336	13.2	110	4.3	231	9.1
3" LARGE	645	25.4	336	13.2	110	4.3	231	9.1

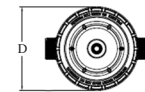
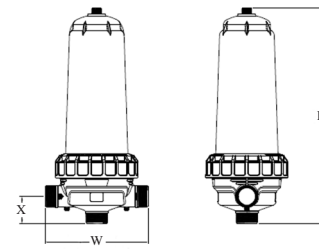

AUTOMATIC FILTERS

	F		E		L		W		R		T		S		S	
	mm	in	mm	in	mm	in	mm	in	mm	in	mm	in	mm	in	mm	in
1 X 2"	572	23	270	11	842	33	262	10	894	35	151	12	644	25	1483	58

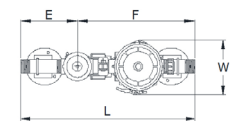
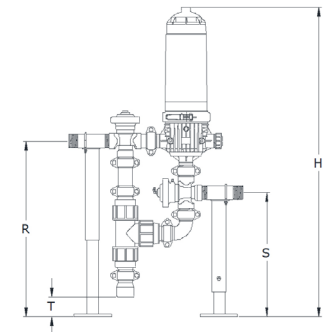

	F	E	D	L	W	R	T	S	H
2 X 2"	272	204	575	698	700	491	257	272	1080
3 X 2"	272	204	830	945	700	511	267	281	1100
4 X 2"	272	204	1065	1220	700	561	292	307	1150
5 X 2"	272	204	1420	1542	700	561	292	307	1150
6 X 2"	272	204	1695	1817	700	561	292	307	1150
2 X 3"	311	230	644	714	785	573	267	309	1162
3 X 3"	311	230	829	956	785	573	267	309	1162
4 X 3"	311	230	1065	1220	785	623	292	334	1212
5 X 3"	311	230	1419	1553	785	623	292	334	1212
6 X 3"	311	230	1694	1828	785	623	292	334	1212
6 X 3"	311	230	1694	1848	785	633	320	355	1257

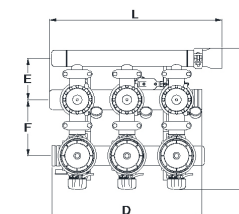
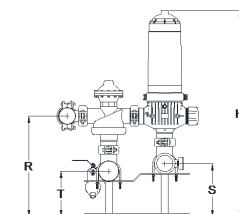

IRRIGATION SYSTEMS



	L		H		T		R		D		S	
	mm	in	mm	in	mm	in	mm	in	mm	in	mm	in
4 x 4"	1305	51	1785	70	645	25	320	12	1195	47	1248	49
5 x 4"	1580	62	1785	70	645	25	320	12	1470	58	1248	49
6 x 4"	1870	73	1890	74	700	27	350	13	1779	70	1328	52
7 x 4"	2145	84	1890	74	700	27	350	13	2054	81	1328	52
8 x 4"	2420	95	1890	74	700	27	350	13	2329	91	1328	52
9 x 4"	2700	106	2025	79	773	30	390	15	2612	102	1433	56
10 x 4"	3110	122	2025	79	773	30	390	15	3024	119	1433	56

W = 1200 mm (47") E = 277 mm (11")

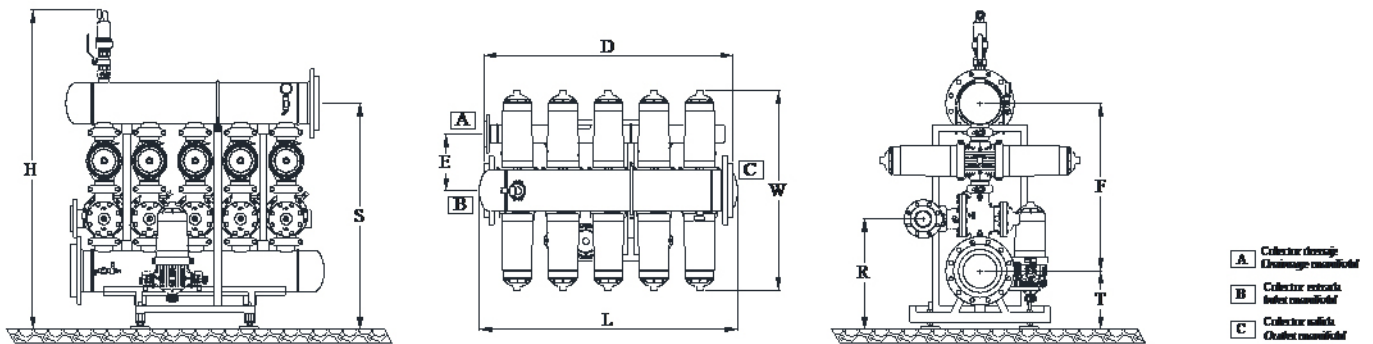

IRRIGATION SYSTEMS

CEPEX FILTRATION



CONTROLLERS

	CODE
CEPEX BACKFLUSHING CONTROLLER 09T01 220V 1 OUTLET	58389
CEPEX BACKFLUSHING CONTROLLER 09T02 220V 2 OUTLET	58390
CEPEX BACKFLUSHING CONTROLLER 09T03 220V 3 OUTLET	58391
CEPEX BACKFLUSHING CONTROLLER 09T01 12V LATCH 1 OUTLET	58392
CEPEX BACKFLUSHING CONTROLLER 09T02 12V LATCH 2 OUTLET	58393
CEPEX BACKFLUSHING CONTROLLER 09T03 12V LATCH 3 OUTLET	58394
CEPEX BACKFLUSHING CONTROLLER 09T04 12V LATCH 4 OUTLET	58395
CEPEX BACKFLUSHING CONTROLLER 09T05 12V LATCH 5 OUTLET	58396
CEPEX BACKFLUSHING CONTROLLER 09T06 12V LATCH 6 OUTLET	58397
CEPEX BACKFLUSHING CONTROLLER 09T07 12V LATCH 7 OUTLET	58398
CEPEX BACKFLUSHING CONTROLLER 09T08 12V LATCH 8 OUTLET	58399
CEPEX BACKFLUSHING CONTROLLER 09T09 12V LATCH 9 OUTLET	58400
CEPEX BACKFLUSHING CONTROLLER 12T11 12V LATCH 10 OUTLET	46750
CEPEX BACKFLUSHING CONTROLLER 12T12 12V LATCH 11 OUTLET	46751
CEPEX BACKFLUSHING CONTROLLER 12T12 12V LATCH 12 OUTLET	46752



CORRESPONDENCE BETWEEN AUTOMATIC FILTRATION BATTERIES AND CONTROLLERS

OUTLETS	Filters			Controllers	
	Filters 2"	Filters 3"	Filters 4"	220 VAC	12V LATCH
1	47150			58389	58392
	47151				
2	47152	46725		58390	58393
	47153				
	46720				
3	46721	46726		58391	58394
4	46722	46727	46731		58395
5	46723	46728	46732		58396
6	46724	46729	46733		58397
		46730			
7			46734		58398
8			46735		58399
9			46736		58400
10			46737		46750
11					46751
12					46752

Description:

The filtration battery controller is made by one only structure with all the necessary elements for an autonomal working of the filtration system.

There is a wide range of control units with voltage AC and DC, which allow an automatation of the different filtering stations or filtration systems.

Complementary information

The control unit incorporate the necessary components to transform the filtration system into a different system completely autonome and automatic:

- Controller: it save all the information, process it and starts the backwashing process of the filters when it is needed.
- Differential pressure gauge: all the control units incorporate a pressure gauge working by pressure difference, it allows the direct reading of the pressure difference in the in-out of the system and the differnce value fixed to start the backwashing process.
- Solenoids: these are controlled by the controller, they send the hydraulic signal for changing to the 3 way valve, sequentially, it means station by station, for the starting of the backwashing process.
- Hydraulic control, connection fittings: it is used for the hydraulic connection of the Control Unit with the Filtration system. All the endings of the micropipes in the control unit are well identified and jointed into a group to make easy and fast the connection with the correspondences in the filtration system.



а т е к
ч и с т ы е т е х н о л о г и и